

M4 X 0.50P

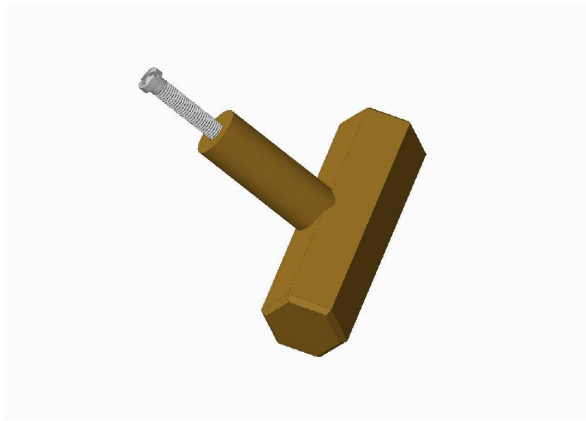
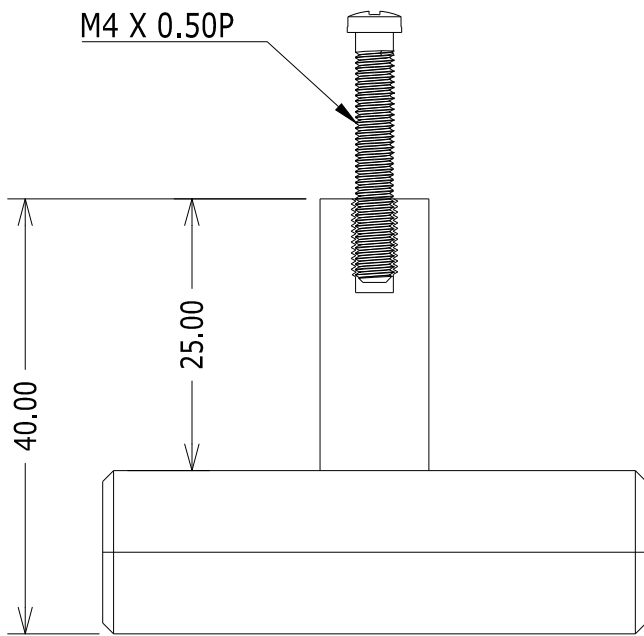

NOTE : All diensions are in MM
Protective lacquer to prevent oxidisation and corrosion.
Suitable for all appliance doors.

Cleaning & Maintenance : Wipe clean with warm water and a soft cloth.
Avoid abrasive towels, sponges, cleaning, sprays
bleach and hand sanitizers.

WEIGHT : 093 g.

MATERIAL : Brass

SKU : P60,P61,P62,P63

FINISH : Brushed



TITLE : Brass Door Knobs

DATE :